

Item	Qty.	Description
--	2	16.732"h aluminum Leg (lower)
--	2	16.732"h aluminum Leg (lower w/ Velcro)
--	2	16.732"h aluminum Leg (upper)
--	2	16.732"h aluminum Leg (upper w/Velcro)
--	1	30"w x 21.5"d Counter Base
--	1	30"w x 21.5"d Counter Shelf
--	1	30"w x 21.5"d Counter Top

Steps:

*Note: Assemble counter upside-down.*

- 1) Attach upper legs to underside of Counter Top. Twist to tighten.
- 2) Connect lower Legs through Counter Shelf to upper Legs, as shown.
- 3) Place Counter Base over lower Legs & secure with wing nuts.
- 4) Turn counter unit over & affix fabric graphic to assembly using Velcro.

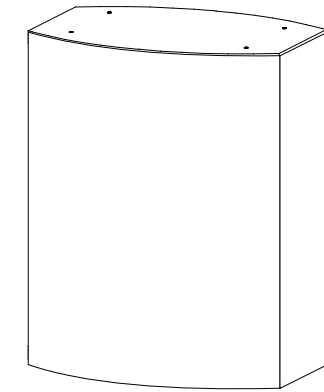

When assembled

*Assemble unit upside-down.*

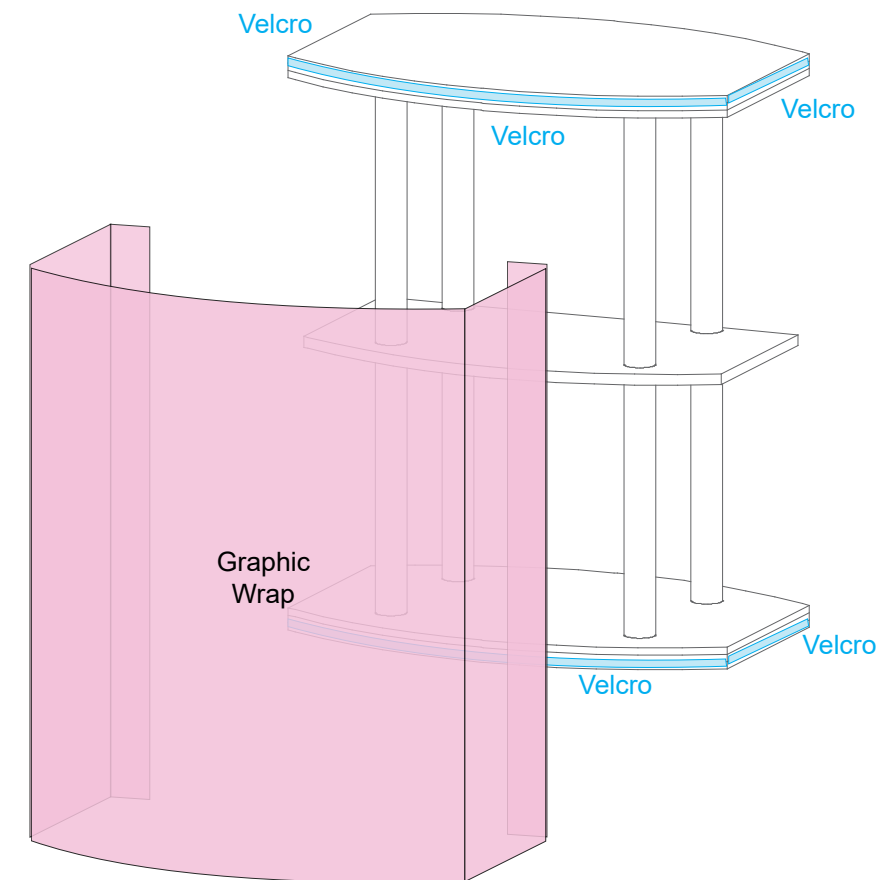
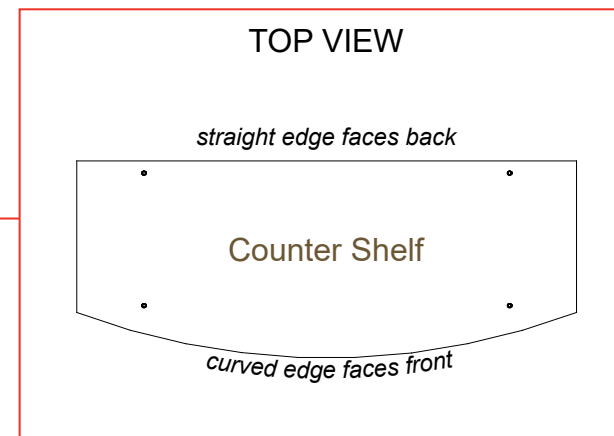
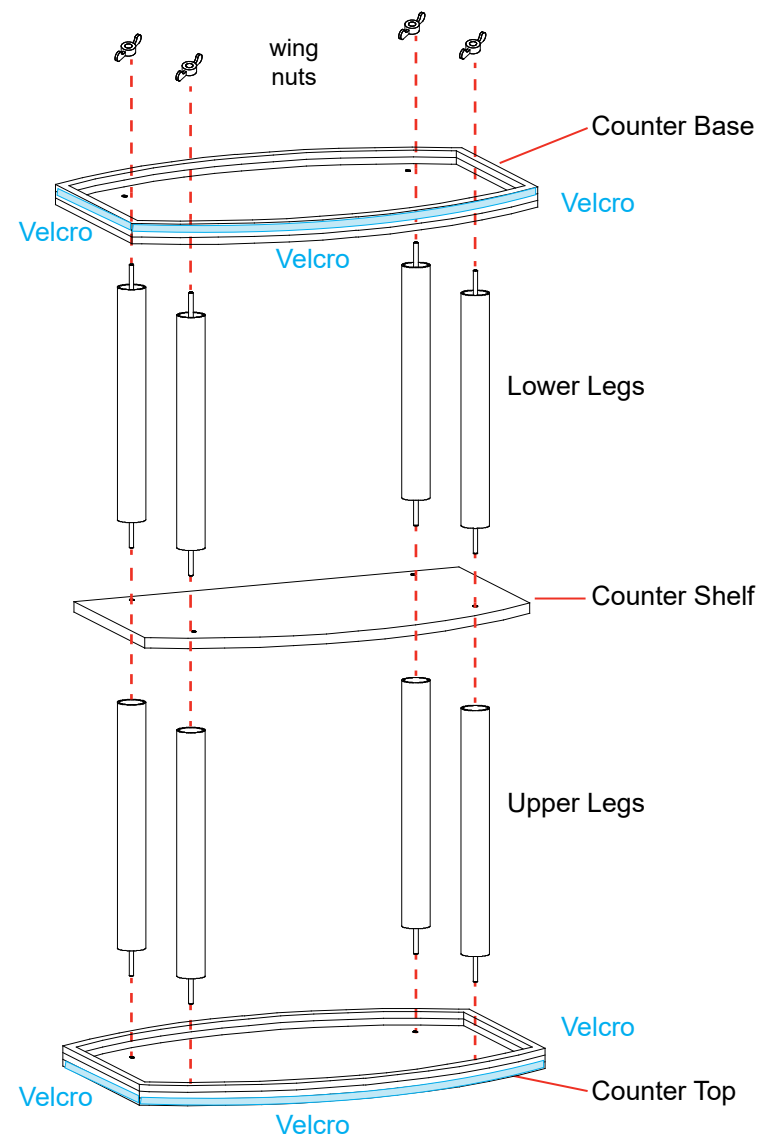

*Note: Velcro must face front of assembled counter.*

# SETUP INSTRUCTIONS

## General Setup Instructions

- Read entire setup instruction manual prior to unpacking parts and pieces.
- The setup instructions are created specifically for this configuration.
- Setup instructions are laid out sequentially in steps, including exploded views with detailed explanation for assembly.

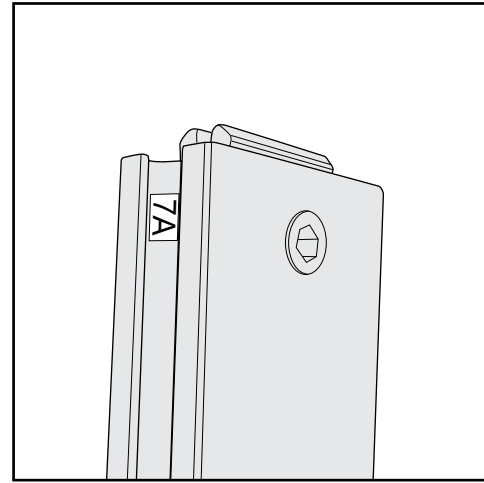

Part Identification - Numbering

## Cleaning & Packing

- For Cleaning Metal, Plex, & Laminate Parts: Use a **MILD NON-ABRASIVE** cleanser and soft cloth/paper towel to clean all surfaces.
- Keep exhibit components away from heat and prolonged sun exposure.  
**Heat and UV exposure will warp and fade components.**
- Retain all provided Packing Materials. All provided packing materials are for ease of repacking & component protection.

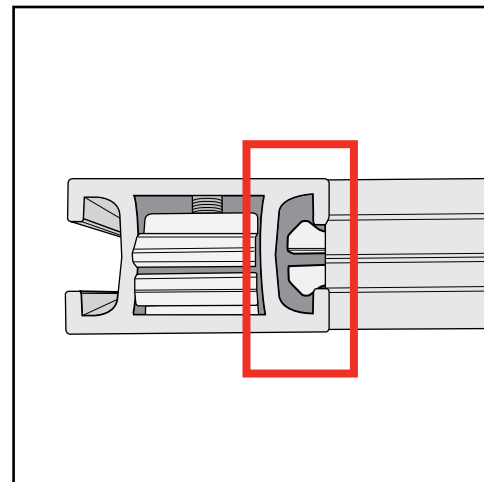

Engaged Lock



**WARNING**



DO NOT USE POWER TOOLS



ALL CONNECTIONS MUST BE TIGHTLY SECURED

## Disassembly

- For loss prevention, keep all knobs & connectors attached to extrusions during disassembly.

## Top View of Each Level

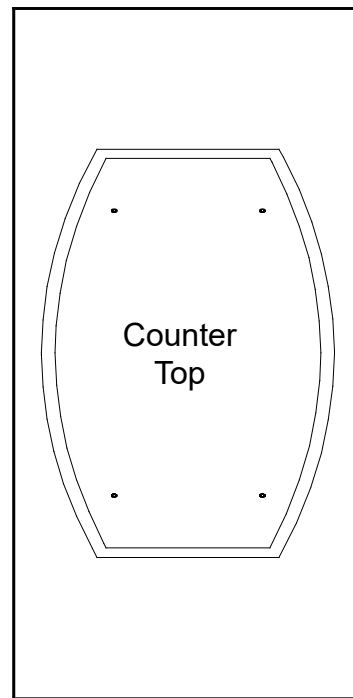

Level 1

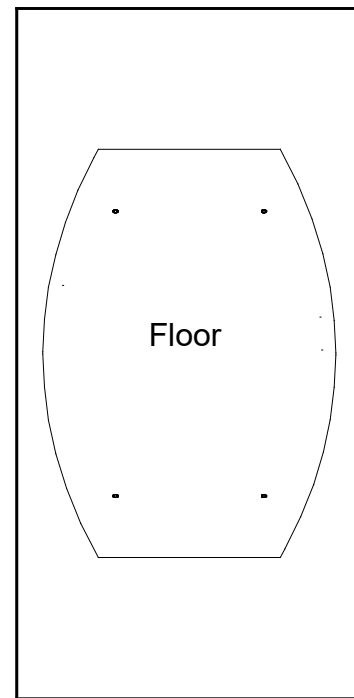

Level 2  
(Bottom level)

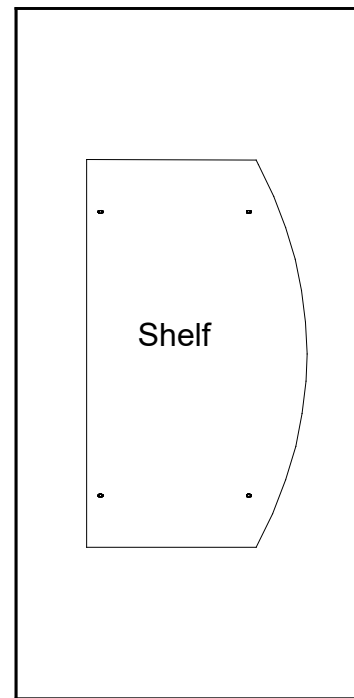

Level 3

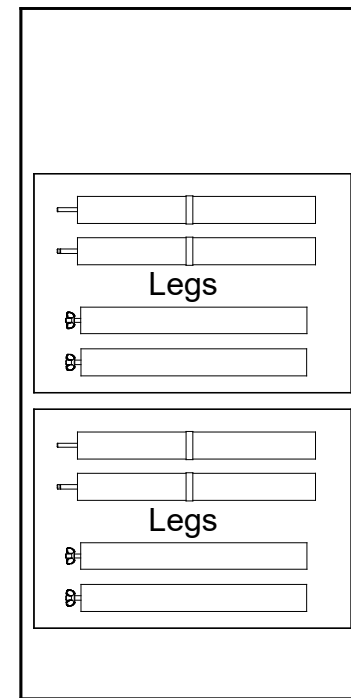

Level 4

